



This report provided free of charge by:
 All in One Auto Group
 25284 Pleasant Valley Rd Ste 104, Chantilly, VA 20152
 844-907-1878



Vehicle History Report™

US \$39.99

2019 HONDA INSIGHT LX

VIN: 19XZE4F12KE013682
 SEDAN 4 DR
 1.5L I4 F DOHC 16V
 HYBRID
 FRONT WHEEL DRIVE



Branded Title: Salvage



CARFAX 1-Owner vehicle



At least 1 open recall



7 Service history records



Personal vehicle



51,579 Last reported odometer reading

CARFAX HAS THE MOST ACCIDENT & DAMAGE INFORMATION



This CARFAX Report Provided by:
All in One Auto Group

This CARFAX Vehicle History Report is based only on information supplied to CARFAX and available as of 10/2/20 at 8:05:14 AM (CDT). Other information about this vehicle, including problems, may not have been reported to CARFAX. Use this report as one important tool, along with a vehicle inspection and test drive, to make a better decision about your next used car.



Ownership History

The number of owners is estimated

Owner 1

Year purchased	2019
Type of owner	Personal
Estimated length of ownership	1 yr. 7 mo.
Owned in the following states/provinces	Florida
Estimated miles driven per year	32,403/yr
Last reported odometer reading	51,579



Title History

CARFAX guarantees the information in this section

Owner 1

Salvage Junk Rebuilt Fire Flood Hail Lemon	Alert! Problem Found
Not Actual Mileage Exceeds Mechanical Limits	No Problem



ALERT! - Severe problems were reported by a state Department of Motor Vehicles (DMV). This vehicle does not qualify for the CARFAX Buyback Guarantee.



Additional History

Owner 1

Not all accidents / issues are reported to CARFAX

Total Loss Total loss reported on 06/11/2020.	Total Loss Reported
Structural Damage CARFAX recommends that you have this vehicle inspected by a collision repair specialist.	No Issues Reported
Airbag Deployment Airbag deployment reported on 06/29/2020.	Airbag Deployment
Odometer Check No indication of an odometer rollback.	No Issues Indicated
Accident / Damage DMV title problems reported. Accident reported on 06/11/2020. Damage reported on 06/29/2020.	Severe Damage
Manufacturer Recall At least 1 manufacturer recall requires service. Locate an authorized Honda dealer to obtain more information about this recall.	Recall Reported
Basic Warranty Original manufacturer warranty likely voided by manufacturer after vehicle was severely damaged.	Warranty Voided



Detailed History



Owner 1

Purchased: 2019

Personal Vehicle
32,403 mi/yr



Mileage	Source	Comments
10/27/2018	3 Holler Honda Orlando, FL 877-764-1590 https://hollerhonda.com/ ★ 4.6 / 5.0 95 Verified Reviews ✓ ♥ 2,239 Customer Favorites	Vehicle serviced - Pre-delivery inspection completed
01/29/2019	26 Florida Motor Vehicle Dept. Kissimmee, FL Title #0133728457	Vehicle purchase reported - Title issued or updated - Registration issued or renewed - First owner reported - Titled or registered as personal vehicle - Loan or lien reported - Vehicle color noted as White
02/01/2019	171 Holler Honda Orlando, FL 877-764-1590 https://hollerhonda.com/ ★ 4.6 / 5.0 95 Verified Reviews ✓ ♥ 2,239 Customer Favorites	Vehicle serviced - Window tint installed
02/11/2019	Florida Motor Vehicle Dept. Kissimmee, FL Title #0133728457	Title issued or updated - Registration issued or renewed - Titled or registered as personal vehicle - Loan or lien reported - Vehicle color noted as White
06/13/2019	10,222 Holler Honda Orlando, FL 877-764-1590 https://hollerhonda.com/ ★ 4.6 / 5.0 95 Verified Reviews ✓	Vehicle serviced - Maintenance inspection completed - Oil and filter changed - Tire condition and pressure checked - Tires rotated

 **2,239** Customer Favorites

08/12/2019 20,394 Valvoline Instant Oil Change
Clermont, FL
352-243-0900
vioc.com
 **4.7 / 5.0**
[109 Verified Reviews](#) 

 **Vehicle serviced**
- Oil and filter changed

 **340** Customer Favorites

10/31/2019 30,402 Holler Honda
Orlando, FL
877-764-1590
<https://hollerhonda.com/>
 **4.6 / 5.0**
[95 Verified Reviews](#) 

 **Vehicle serviced**
- Maintenance inspection completed
- Oil and filter changed
- Tire condition and pressure checked
- Tires rotated
- Front wiper blades/refills replaced

 **2,239** Customer Favorites

02/18/2020 Florida
Motor Vehicle Dept.
Kissimmee, FL
Title #0133728457

Registration issued or renewed
- Titled or registered as personal vehicle
- Loan or lien reported
- Vehicle color noted as White

02/25/2020 40,650 Coggin Honda of Orlando
Orlando, FL
855-433-7523
cogginhondaorlando.com
 **4.5 / 5.0**
[377 Verified Reviews](#) 

 **Vehicle serviced**
- Tires rotated
- Oil and filter changed

 **554** Customer Favorites

05/29/2020 American Honda Motor Co.

Manufacturer Safety-related recall issued
- NHTSA #20V-314
- Recall #W7F 2019-20 Insight Fuel Pump Motor Safety
- Recall
- Status: Remedy Available



Locate an authorized [Honda dealer](#) to obtain more information about this recall

- [Learn more about this recall](#)

Description: American Honda Motor Co., Inc. (Honda) is recalling certain 2019 - 2020 model year Insight vehicles that may be equipped with a fuel pump module manufactured with low density impellers. Over time, low density impellers may excessively absorb fuel and deform. Impeller deformation may cause the fuel pump to become inoperative.

Fuel pump inoperability could prevent an engine from starting or stall an engine while driving, increasing the risk of a crash.

Remedy: Please call any authorized Honda dealer and make an appointment to have the fuel pump assembly replaced for free. For additional questions or to get help locating a dealer, owners may contact American Honda's Customer Support and Campaign Center at 1-888-234-2138.

06/05/2020 51,063 Holler Honda
Orlando, FL
877-764-1590
<https://hollerhonda.com/>
 **4.6 / 5.0**
[95 Verified Reviews](#) 

 **Vehicle serviced**
- Maintenance inspection completed
- Oil and filter changed

 **2,239** Customer Favorites

06/11/2020 Florida
Damage Report

 **TOTAL LOSS VEHICLE**
- Accident reported
- Vehicle declared a total loss by an insurance company
- Damage to front

CARFAX HAS THE MOST ACCIDENT & DAMAGE INFORMATION

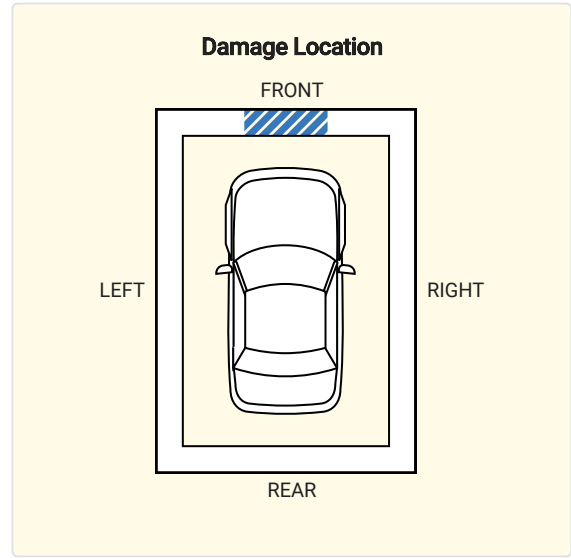

There are many reasons an insurance company will declare a vehicle a total loss. Have this vehicle inspected by a qualified technician before you buy. [Learn more](#)

06/29/2020

Damage Report

-  **Damage reported**
- Damage to front
 - Damage to right front
 - Airbag deployed
- [CARFAX Airbag Tips](#)

CARFAX HAS THE MOST ACCIDENT & DAMAGE INFORMATION

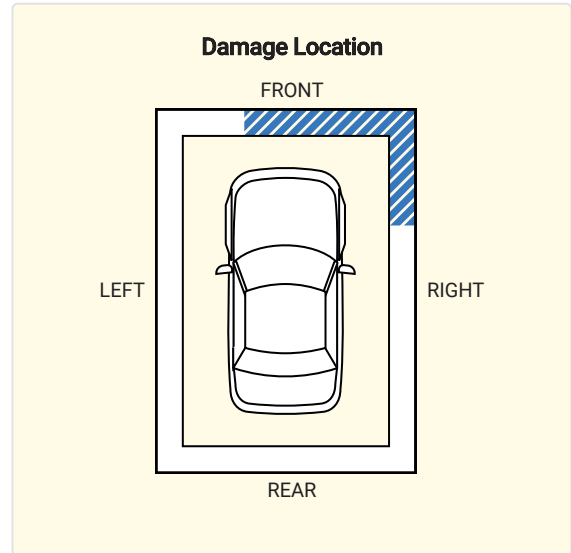

08/25/2020

Florida
Motor Vehicle Dept.
Kissimmee, FL
Title #0133728457

Registration issued or renewed

- Titled or registered as personal vehicle
- Vehicle color noted as White

09/01/2020

51,579

Florida
Motor Vehicle Dept.
Sanford, FL

Odometer reading reported

09/02/2020

Florida
Motor Vehicle Dept.

Title or registration issued to insurance company

09/02/2020

Florida
Motor Vehicle Dept.
Sanford, FL
Title #0133728457

 **SALVAGE TITLE/CERTIFICATE ISSUED**

- Vehicle color noted as White

09/04/2020

Damage Report

**SALVAGE TITLE/CERTIFICATE ISSUED**

Have Questions? Consumers, please visit our Help Center at www.carfax.com. Dealers or Subscribers, please visit our Help Center at www.carfaxonline.com.



Glossary

Accident Indicator

CARFAX receives information about accidents in all 50 states, the District of Columbia and Canada.

Not every accident is reported to CARFAX. As details about the accident become available, those additional details are added to the CARFAX Vehicle History Report. CARFAX recommends that you have this vehicle inspected by a qualified mechanic.

- According to the National Safety Council, Injury Facts, 2015 edition, 8% of the 254 million registered vehicles in the U.S. were involved in an accident in 2013. Over 74% of these were considered minor or moderate.
- This CARFAX Vehicle History Report is based only on information supplied to CARFAX and available as of 10/2/20 at 8:05:14 AM (CDT). Other information about this vehicle, including problems, may not have been reported to CARFAX. Use this report as one important tool, along with a vehicle inspection and test drive, to make a better decision about your next used car.

Airbag Deployment

Occurs when the driver, passenger or side airbag has been used or deployed during a crash or other incident. If an airbag has been deployed, it must be replaced by a qualified technician. Have this car inspected by a mechanic prior to purchase. Use [CARFAX Airbag Tips](#) to make sure this vehicle's airbag system is functional.

Damage Indicator

Damage can be a result of many different types of events. Examples include contact with objects (other cars, trees, traffic signs, road debris, etc), vandalism, or weather-related events. Not every damage event is reported to CARFAX. As details about the damage event become available, those additional details are added to the CARFAX Vehicle History Report. CARFAX recommends that you have this vehicle inspected by a qualified mechanic.

- This CARFAX Vehicle History Report is based only on information supplied to CARFAX and available as of 10/2/20 at 8:05:14 AM (CDT). Other information about this vehicle, including problems, may not have been reported to CARFAX. Use this report as one important tool, along with a vehicle inspection and test drive, to make a better decision about your next used car.

First Owner

When the first owner(s) obtains a title from a Department of Motor Vehicles as proof of ownership.

Manufacturer Recall

Automobile manufacturers issue recall notices to inform owners of car defects that have come to the manufacturer's attention. Recalls also suggest improvements that can be made to improve the safety of a particular vehicle. Most manufacturer recalls can be repaired at no cost to you.

Ownership History

CARFAX defines an owner as an individual or business that possesses and uses a vehicle. Not all title transactions represent changes in ownership. To provide estimated number of owners, CARFAX proprietary technology analyzes all the events in a vehicle history. Estimated ownership is available for vehicles manufactured after 1991 and titled solely in the US including Puerto Rico. Dealers sometimes opt to take ownership of a vehicle and are required to in the following states: Maine, Massachusetts, New Jersey, Ohio, Oklahoma, Pennsylvania and South Dakota. Please consider this as you review a vehicle's estimated ownership history.

Salvage Title

A Salvage Title is issued on a vehicle damaged to the extent that the cost of repairing the vehicle exceeds approximately 75% of its pre-damage value. This damage threshold may vary by state. Some states treat Junk titles the same as Salvage but the majority use this title to indicate that a vehicle is not road worthy and cannot be titled again in that state. The following eleven states also use Salvage titles to identify stolen vehicles - AZ, FL, GA, IL, MD, MN, NJ, NM, NY, OK and OR.

Title Issued

A state issues a title to provide a vehicle owner with proof of ownership. Each title has a unique number. Each title or registration record on a CARFAX report does not necessarily indicate a change in ownership. In Canada, a registration and bill of sale are used as proof of ownership.

Total Loss Vehicle

An insurance or fleet company declares a vehicle a total loss when a claim exceeds approximately 75% of its pre-damage value or if the vehicle is stolen and not recovered. This damage threshold varies by company. These companies typically take possession and obtain the title. Not all total loss vehicles result in a DMV-reported branded title. This may occur when an insurance company's definition of a total loss is different than the state DMV's definition for a branded title or when the owner of the vehicle is a self-insured company, like a fleet or rental company.

Follow Us:



[facebook.com/CARFAX](https://www.facebook.com/CARFAX)



[@CARFAXinc](https://twitter.com/CARFAXinc)



About CARFAX

CARFAX DEPENDS ON ITS SOURCES FOR THE ACCURACY AND RELIABILITY OF ITS INFORMATION. THEREFORE, NO RESPONSIBILITY IS ASSUMED BY CARFAX OR ITS AGENTS FOR ERRORS OR OMISSIONS IN THIS REPORT. CARFAX FURTHER EXPRESSLY DISCLAIMS ALL WARRANTIES, EXPRESS OR IMPLIED, INCLUDING ANY IMPLIED WARRANTIES OF MERCHANTABILITY OR FITNESS FOR A PARTICULAR PURPOSE.

© 2020 CARFAX, Inc., a unit of IHS Markit Ltd. All rights reserved.
10/2/20 8:05:14 AM (CDT)

I have reviewed and received a copy of the CARFAX Vehicle History Report for this 2019 HONDA INSIGHT vehicle (VIN: 19XZE4F12KE013682), which is based on information supplied to CARFAX and available as of 10/2/20 at 9:05 AM (EDT).

Customer Signature

Date

Dealer Signature

Date